

700-960MHz 5dBi/1700-2700MHz 10dBi PANEL+RG58(40CM)+N FEMALE



ROHS

Specifications/Special Features :

This antenna is designed for
LTE/GSM/WCDMA/UMTS wireless communications

Specification	
Gain (dBi)	700-960MHz 5dBi / 1700-2700MHz 10dBi
Antenna Type	PANEL
Polarization	Vertical
Beam width deg.	Horz.90° Vert.40°
V.S.W.R.	<=2.1
Frequency	700-960MHz /1700-2700MHz
Antenna Connector	N Female
Antenna Cable	RG58 Length=40 cm
Dimensions	L233×W200XH60 mm
Mounting Kit	U-bolts
Radome Material	ABS polymer (white)
Weight	1KG

PA-0727-01

700-960MHz 5dBi/1700-2700MHz 10dBi PANEL+RG58(40CM)+N FEMALE

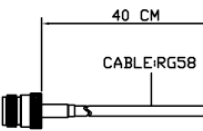
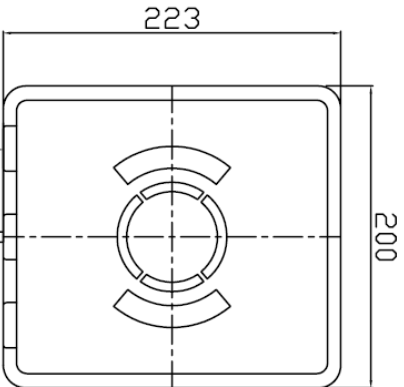
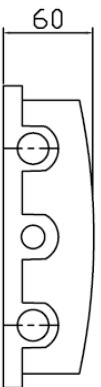

ANTENNA CONNECTOR : N FEMALE

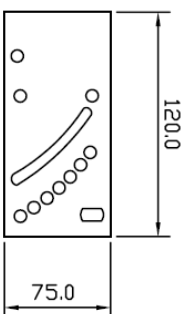
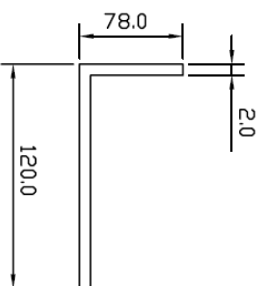
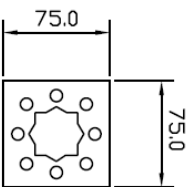

⊙ X4
WASHER
⊗ X4
NUT

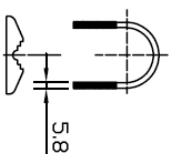
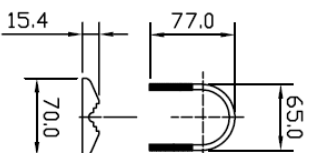

1 FREQUENCY RANGE : 700-960/1700-2700MHz

2 GAIN : 700-960 5dBi/1700-2700MHz 10dBi

3 VSWR : < 2.1 : 1

4 IMPEDANCE : 50 Ω

5 POLARIZATION : LINEAR VERTICAL

6 Antenna Connector : N FEMALE

7 Maximum Power : 100W

8 Dimensions : L223XW200XH60mm

9

10

11

12

13

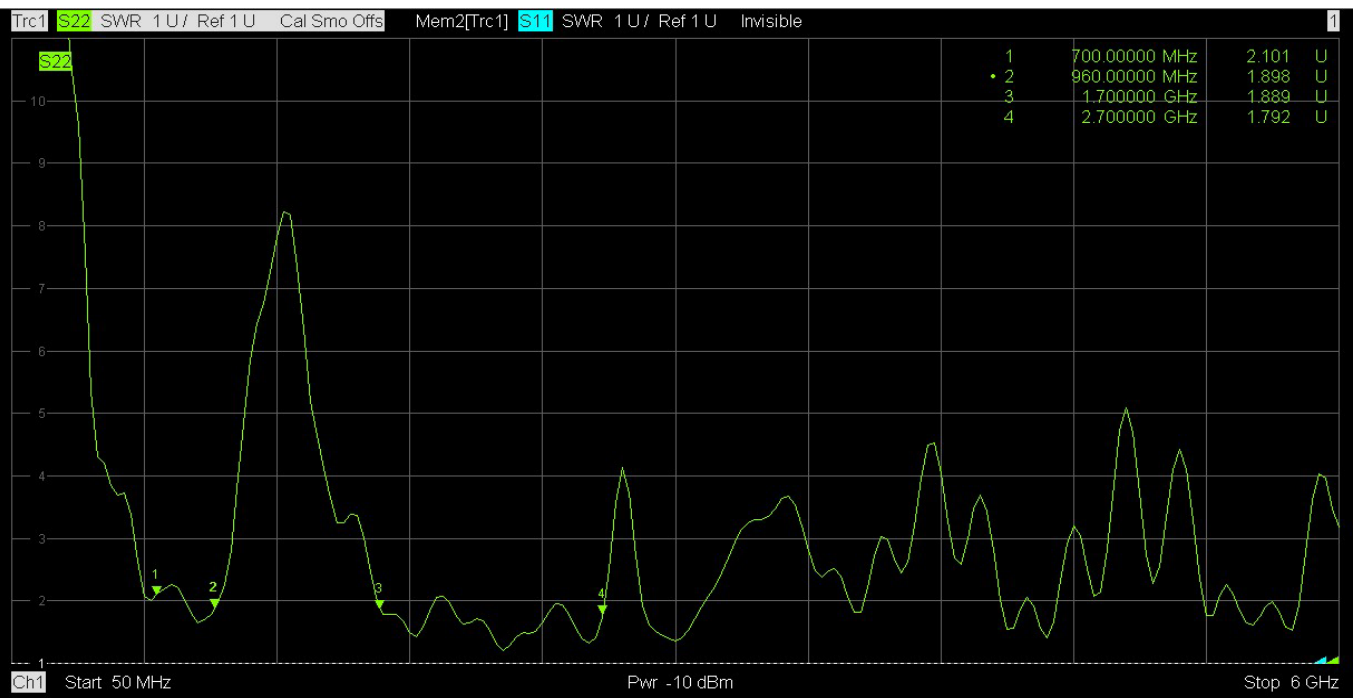

H-PLANE

E-PLANE

